

Quick Start Guide: ULTRAPENx2™ PTBT2 with the Ultrapen PTBTX2™ APP pH and Temperature Pen for Use with your Mobile Device

CHANGING THE PTBT2 LIVE / HOLD MODE

1. Press and release the PEN BUTTON on the PTBT2 to turn it ON and place it into STANDBY mode.

2. Tap the PREFERENCES button  in the Feature Navigation Bar.

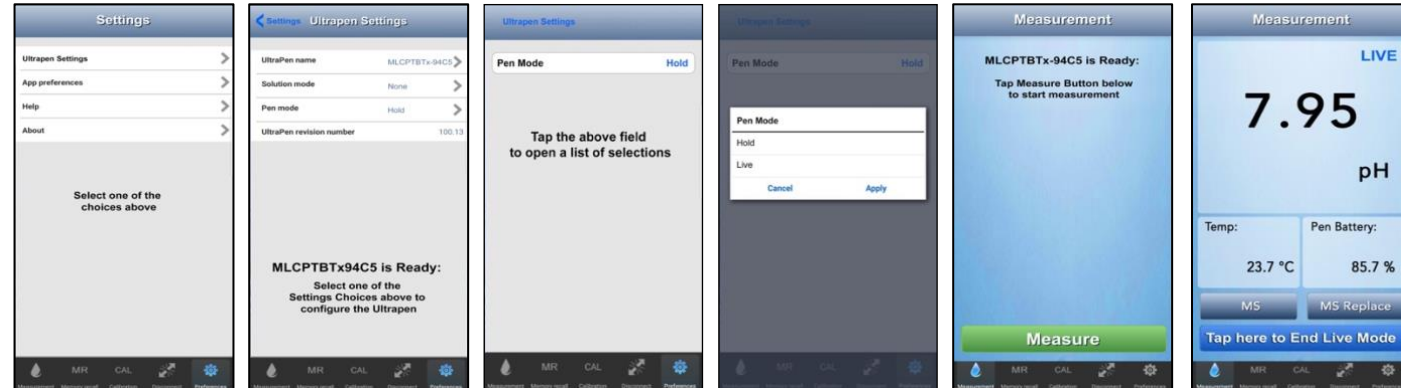

3. Tap the line that says **Ultrapen Settings**.
4. Tap the Pen Mode line on the screen.
5. The App will display the current mode setting. Tap the Pen Mode Field.
6. Select Live or Hold, then tap **APPLY**.
7. Return to the Measurement screen and tap the GREEN Measure button.
8. Either tap the BLUE button to manually stop LIVE mode, or it will stop by itself after 5 minutes.

EXPORTING DATA RECORDS

1. Tap the **MEMORY RECALL**  button in the Feature Navigation Bar.
2. Tap the **EDIT** button in the upper right corner of the Record List. The Record List Edit screen will appear.
3. Tap individual records to select them for export, or tap the BLUE, **SELECT ALL** button to select the entire record list.
4. As you select records the **CLEAR** and **DELETE** buttons update to show the number of records selected.
5. Tap the SEND button in the upper left corner of the record list. The default email program for your mobile device will open.
6. An Attachment will be present containing the selected records.
 - The format of the attachment will be either .csv (default), .xls or .xlsx.
 - The format for attachments can be changed by opening the PREFERENCES > APPLICATION PREFERENCE screen.
7. Complete the email in the standard manner for your email application.

MAINTENANCE

BATTERY REPLACEMENT

When the PTBT2 charge level falls below 25% immediately replace the battery with a new N type battery.

1. In a **CLEAN, DRY** place unscrew the battery cap in a counter-clockwise direction.
2. Slide the cap and battery housing out of the PTBT2.
3. Remove the depleted battery from its housing.
4. Insert a new battery into the battery housing oriented with the negative end touching the spring.
5. Align the groove along the battery housing with the guide bump inside the PTBT2 case and slide the battery housing back in.
6. Screw the PTBT2 battery cap back on in a clockwise direction. **Do not over tighten.**

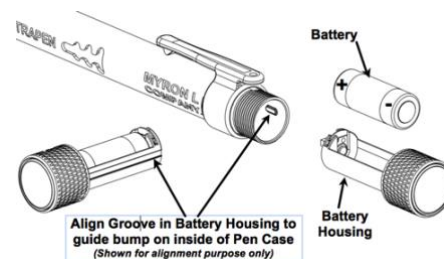

ROUTINE MAINTENANCE

- After each use **ALWAYS** rinse the sensor with clean water (preferably DI, RO, or purified water).
- **ALWAYS** replace the Protective Cap on the sensor after each use. **DO NOT** push the cap past the Cap Stop.
 - Make sure to fill the Protective / Hydration Cap half way with MLC Storage Solution.
- Do not drop, throw, or otherwise strike the PTBT2.
- Do not store the PTBT2 in a location where the ambient temperatures exceeds its Operating/Storage Temperature limits.
- Instructions for cleaning the PTBT2 sensor can be found in the PTBT2 Operation Manual on the Myron L® Company website.

MYRON L® COMPANY

2450 Impala Drive ♦ Carlsbad, CA 92010-7226 ♦ Phone: +1-760-438-2021
E-Mail: Customer Service – info@myronl.com ♦ Technical Support – techquestions@myronl.com
Website: www.myronl.com

Quick Start Guide: ULTRAPENx2™ PTBT2 with the Ultrapen PTBTX2™ APP pH and Temperature Pen for Use with your Mobile Device

For more detailed instructions on making measurements, calibrating and maintaining the PTBT2, or changing settings and preferences download the full PTBTX2OM Operation Manual found on the Myron L® Company website (www.myronl.com), under the Downloads tab.

TO DOWNLOAD THE NEW PTBTX2 APP



SYSTEM REQUIREMENTS
iOS device running iOS 10.0 or later.
If you are using an iPad,
Search for iPhone Apps
Android device running OS 7.0 or later.

ULTRAPENx2™ PTBT2 LAYOUT

1. **PEN BUTTON** – Press to turn the PTBT2 ON and place it in STANDBY Mode.
2. **BATTERY CAP** – Unscrew to change battery.
3. **LED INDICATOR LIGHT** – Flashes rapidly when the PTBT2 is MEASURING and once every 5 seconds when the PTBT2 is in STANDBY mode.
4. **pH SENSOR** – Includes pH sensor to measure hydrogen ion concentration of solution and temperature sensor.
5. **CAP STOP** – Pushing the protective cap beyond the cap stop may damage the sensor.
6. **PROTECTIVE / HYDRATION CAP** – Protects sensor from damage and holds MLC Storage Solution to preserve sensor functionality.
7. **SCOOP** – Used to hold sample solution when dipping is not possible.

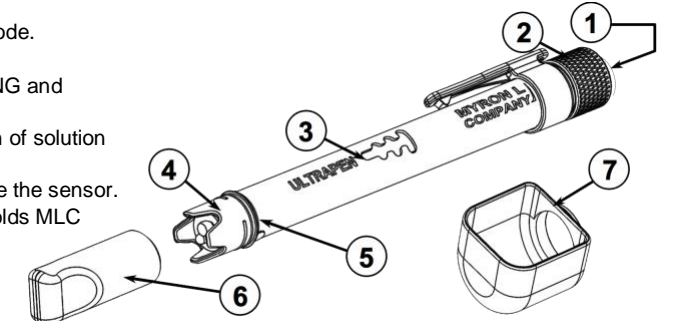

PTBTX2™ APP – FEATURE NAVIGATION BAR

This bar appears at the bottom of all screens. The buttons in this bar are used to navigate between the App's main functional areas.

MEASUREMENT – Returns the App to the Measurement screen.

MEMORY RECALL – Displays a list of saved measurements.

CALIBRATION – Places the App in Calibration Mode.

CONNECT – Opens the App's Bluetooth Connect / Disconnect screen.

- Once a PTBT2 is connected to the App the button label says Disconnect.

PREFERENCES – Opens the App's Preferences & Settings Modes, including an internet link to the full Operation Manual (**HELP**).



USING THE PTBT2

STEP 1 – CONNECT THE PTBT2 TO THE APP

1. On your Device's Home Screen, tap the blue **PTBTX2** icon.
2. Tap the CONNECT button at the bottom of the App display
3. The App will switch to the CONNECT Screen.
4. Press and release the PEN BUTTON to turn the PTBT2 ON.

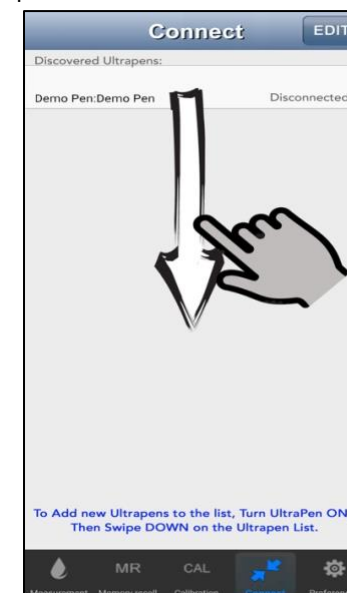

5. Swipe down on the screen. The PTBT2 will appear on the list.

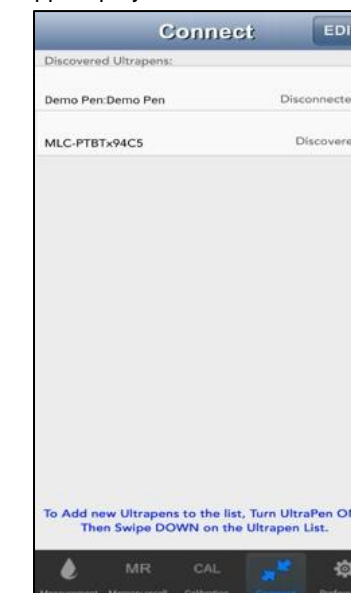

6. Tap the PTBT2's name when it appears. Default: **MLC-PTBTX[Hexadecimal ID]**

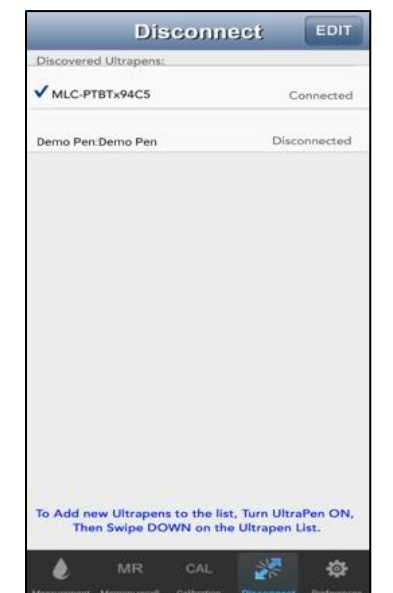

7. The PTBT2 will move to the top of the list and a check mark will appear.

NOTES:

- Some Mobile Devices switch their wireless transmitters to a low power mode when their battery level gets too low. This could affect how easily your PTBT2 and your device connect and communicate.
- **ALWAYS** keep your Mobile Device Charge Level as high as possible.

Quick Start Guide: ULTRAPENx2™ PTBT2 with the Ultrapen PTBTX2™ APP pH and Temperature Pen for Use with your Mobile Device

STEP 2 – MAKE A HOLD MODE MEASUREMENT

1. Dip the PTBT2 sensor in the Sample solution.

2. Tap the MEASUREMENT button  in the Feature Navigation Bar.

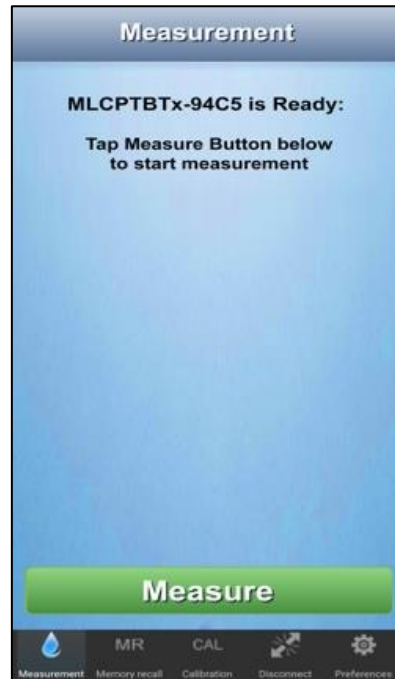

3. If the PTBT2 is OFF this screen will appear.

4. Press the button on the PTBT2.

5. If the PTBT2 is ON and in STANDBY mode, this screen will appear. Tap the GREEN Measure button.

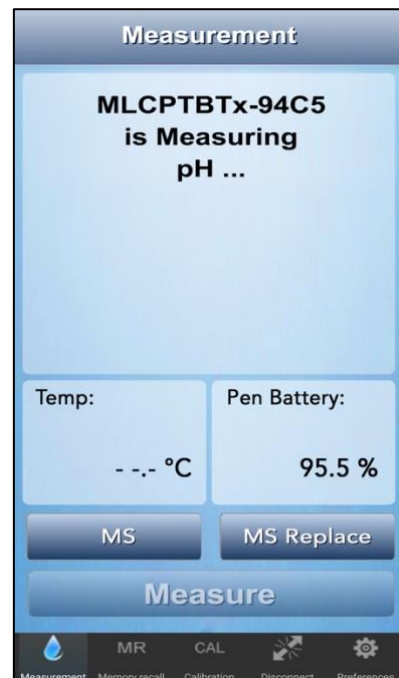

6. Swirl the pen in the sample while the PTBT2 is measuring. The PTBT2's LED will flash rapidly.

7. When the PTBT2 completes the measurement the App will display the values.

TO USE THE SCOOP

- Push the scoop onto the sensor while shifting it gently side-to-side.
- Hold the scoop directly under a vertical sample stream while measuring. Avoid bubbles.
- To remove the scoop, pull it off while shifting it gently side-to-side.

- **MS Button**
Tap to record the last measurement.
- **MS Replace Button**
Tap to replace data in an existing record with data from the last measurement.

Quick Start Guide: ULTRAPENx2™ PTBT2 with the Ultrapen PTBTX2™ APP pH and Temperature Pen for Use with your Mobile Device

CALIBRATING THE PTBT2

NOTE: Required MLC Calibration Solutions: MLC 4.0 pH, 7.0 pH and 10.0 pH Calibration Buffers

1. Rinse the PTBT2 sensor in Myron L® Company Calibration Solution.

2. Press and release the PEN BUTTON on the PTBT2 to turn it ON. 3. Tap the CAL button  in the Feature Navigation Bar.

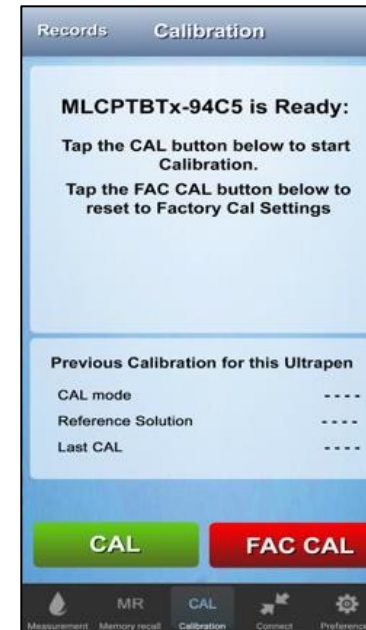

4. Tap the CAL button.

Swirl the pen in the Calibration Buffer while the PTBT2's LED is flashing rapidly.



5. The PTBT2 will identify the Calibration Buffer and complete the 1st Calibration point.

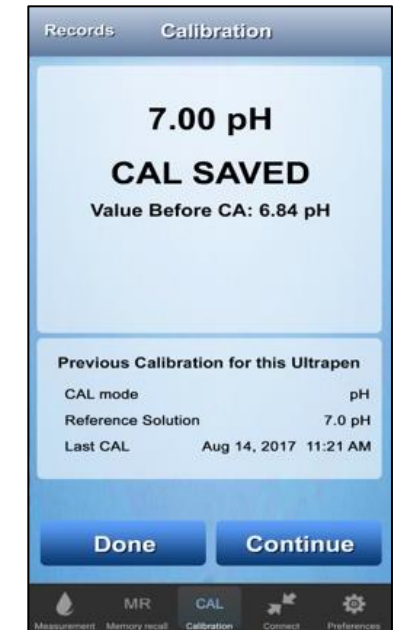

6. Place the PTBT2 sensor in either 4.0 or 10.0 pH Buffer after rinsing the sensor in a separate container of the same buffer, then tap **CONTINUE**.

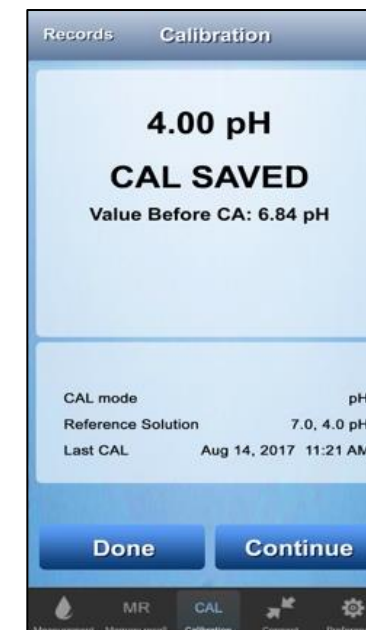

7. The PTBT2 will complete the 2nd CAL Point.

8. Place the PTBT2 sensor in the remaining pH Buffer after rinsing the sensor in a separate container of the same buffer, then tap **CONTINUE**.

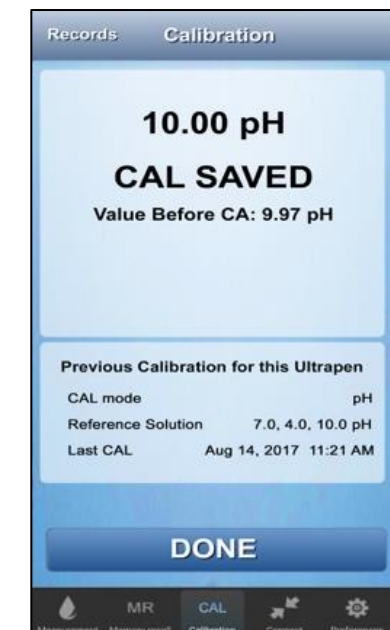

9. When the Calibration is done the the App displays the final Calibration point value and saves a CAL record.

10. Tap the DONE button.

NOTE: **FAC CAL** resets the PTBT2 to factory settings, but **IT DOES NOT** account for current sensor condition.